

Output CA Ø23  
Input CA Ø11.5

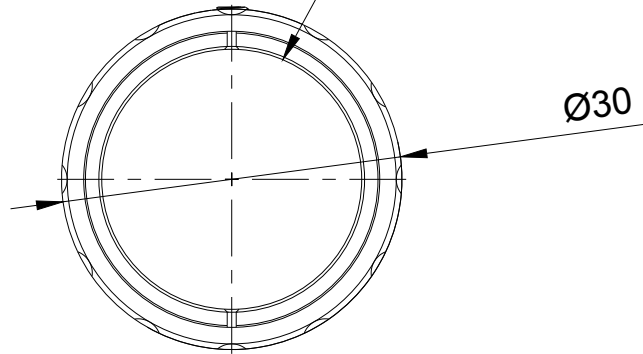

THREAD SM1  
1.035" - 40

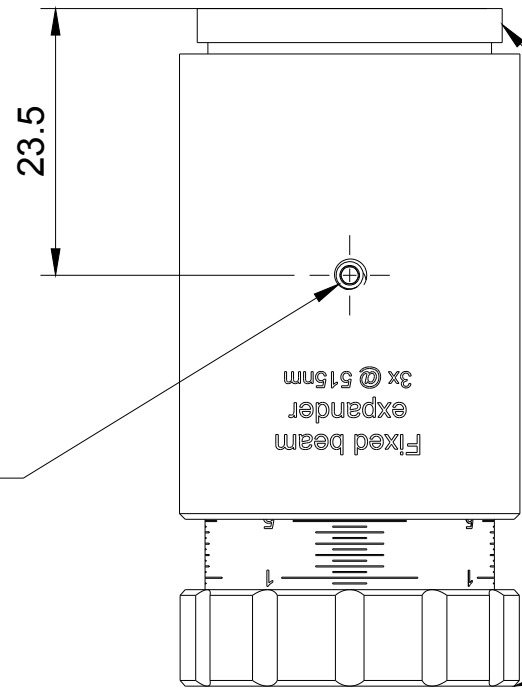
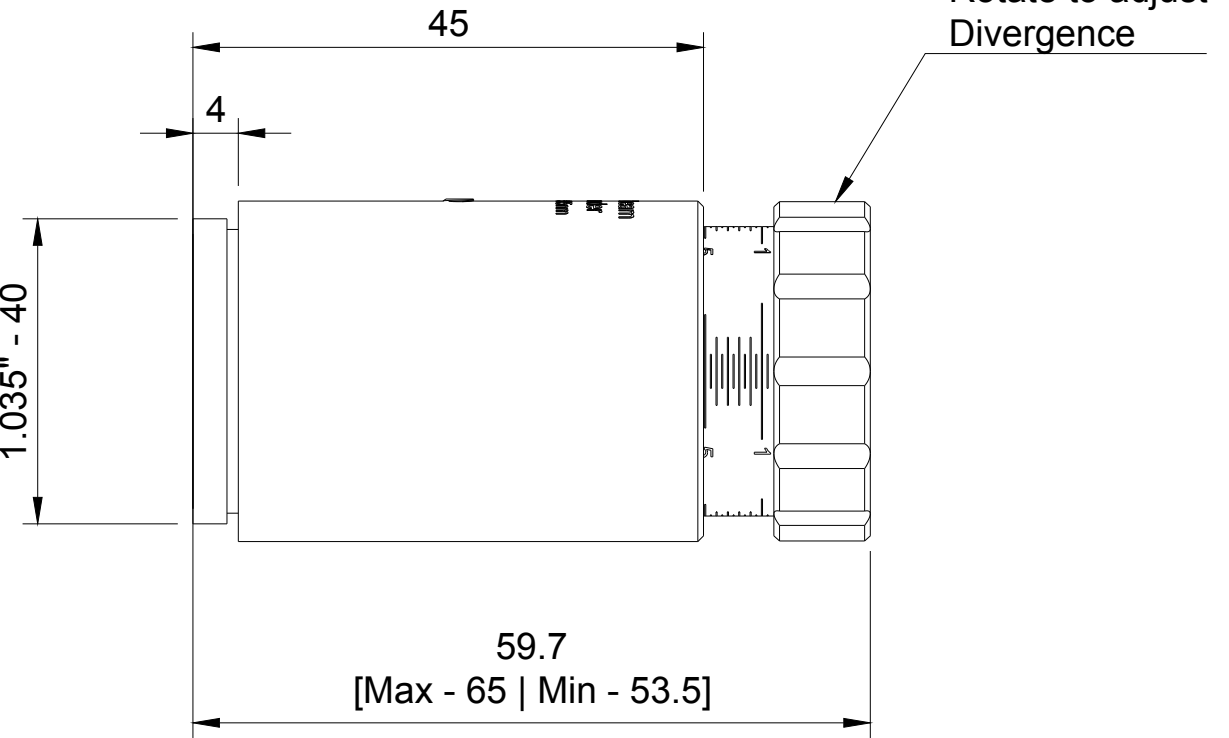

**Default mounting thread:**  
SM1 Male

**Available mounting adapters:**  
SM1 Male to M30x1 Male  
SM1 Male to C-Mount [1" - 32 UN]

**Default mounting thread:**  
SM1 Female [max 2.3mm]

**Available mounting adapters:**  
SM1 Female to M30x1 Male



FOR INFORMATION ONLY  
NOT FOR MANUFACTURING PURPOSES

Dept.	Technical reference 1.5:1	Created by Optogama 18/07/2018	Approved by
		Document type	Document status
		Title FEX3X-515 fixed beam expander 3X @ 515nm	DWG No. FEX3X-515
Rev.	Date of issue	Sheet	1/1