



COMPACT MOTORISED BEAM EXPANDERS

1x - 3x | 1x - 8x

MEX13

MEX18

MEX18-ACH



Table of contents

Table of contents.....	2
1. Safety requirements.....	4
2. Operation principle	5
3. Features and advantages	5
4. Optical design	5
5. Product description	6
5.1.Optical specifications.....	6
5.2.Mechanical specifications	6
5.3.Electronic specifications.....	6
5.4.Conditions	6
5.5.Interfaces.....	7
5.6.Wiring, Pinouts	7
5.7.Identification	7
5.8.Voltage levels (RS-232)	7
5.9.What's in the box?	7
6. Software.....	8
6.1.Hardware requirements (recommended)	8
6.2.System requirements	8
6.3.Supported client operating systems.....	8
6.4.Installing the software	8
6.5.Using the software.....	9
6.6.Main window	10
6.7.Magnification calibration. MOF coefficient	11
6.8.Divergence adjustment. DOF coefficient	11
6.9.Updating the firmware	12
7. Commands	14
7.1.Interface	14
7.2.Description	14
7.3.Serial communication example in Python.....	17
8. Technical drawings	18

MEX

Motorised beam expander

Congratulations on your purchase of the motorised beam expander from Optogama, UAB.

March 2018

Copyright UAB Optogama. All rights reserved.

No part of this manual may be reproduced, transmitted in any form without the permission of Optogama.

Claims will not be accepted and warranty repair will not be carried out in case of improper use, incorrect service and maintenance not according to product instructions. Warranty claim shall not be accepted if there are any signs of:

- Non-authorized alteration
- Disassembling of the device
- Mechanical or any external damage
- If warranty term has expired
- Serial number of the product is missing

Symbols

CAUTION!

Sections marked with this symbol indicate dangerous situations that can result in damage to the device, components connected to it or operator.

NOTE:

Sections marked with this symbol indicate important information on beam expander or about this manual.

Due to constant development of our products we reserve the right to make changes in the production line without further notice. Up-to-date information is available at our website www.optogama.com. If there are any further questions, please contact us.

Optogama is not liable for damage or injury resulting directly or indirectly from use of this product for anything other than its intended purpose.

The motorised beam expander is intended for industrial and scientific use only. If there are any other electrical devices connected to or used in conjunction with the beam expander, all legal regulations and technical standards that are applied to those devices must be observed as well.

For any technical assistance and consultation please contact your local dealer or directly sales@optogama.com.

1. Safety requirements

- All safety instructions must be followed.
- This manual should be read carefully before first intended use.
- All rules and regulations concerning safe operation of lasers must be known and applied while installing and operating motorised beam expander.
- Even when with safety glasses avoid eye contact with direct or scattered laser light while assembling, installing and operating the device.
- The device should never be exposed to dirt, dust or moisture.
- Before any operation make sure the device is installed correctly and well adjusted.
- Protective measures should be considered if necessary.
- Electrical safety requirements must be complied while operating this device.

CAUTION! High laser output power may damage or destroy optical elements.

CAUTION! Make sure laser beam is not converging after passing through the beam expander - it may damage other optical elements along the optical axis.

CAUTION! Device is meant to be used with collimated beam. Users take full responsibility when using the expander with highly converging beam.



2. Operation principle

MEX13(18) series motorised beam expanderS consists of two motorised adjustable lenses. Expansion adjustment is achieved by changing the position of the second lens which is followed continuously by the first one. While changing the magnification level this technology prevents the system from focusing laser beam and damaging optical elements that are situated along the optical axis.

NOTE: No homing required.

CAUTION! Before increasing laser power make sure laser beam is not converging after passing through the beam expander. It may damage optical elements situated along the optical axis.

NOTE: Required laser beam divergence is achieved by adjusting divergence value (**DOF** coefficient) in the software (or terminal).

3. Features and advantages

- Absolute encoders
- All in one design - integrated controller
- Highest beam pointing stability (< 0.1 mrad on request)
- Fused silica optical elements
- No homing required
- Diffraction limited performance for all magnifications

4. Optical design

To achieve best performance and highest pointing stability during operation (<0.5 mrad, <0.2 mrad for PS model) MEX optical design is based on sliding-lenses closed loop design. Neither of the lenses are rotating while changing both zoom and divergence levels.

Optical design of MEX13 and MEX18 series (see Fig 1. below):

Converging > Diverging > Converging

NOTE: Continuous change of expansion and divergence.

NOTE: No ghost reflections.

NOTE: Diffraction limited optical design.

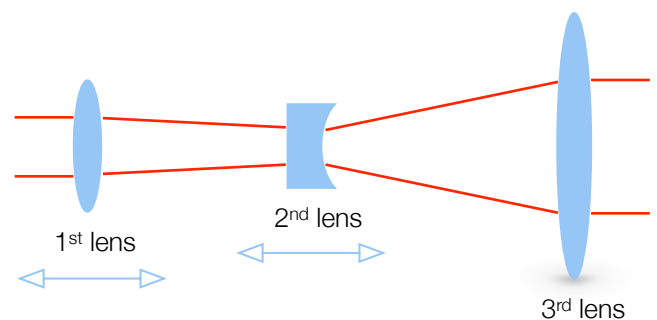

Fig 1. Schematic explanation of optical design for MEX13 and MEX18 series motorised beam expander.

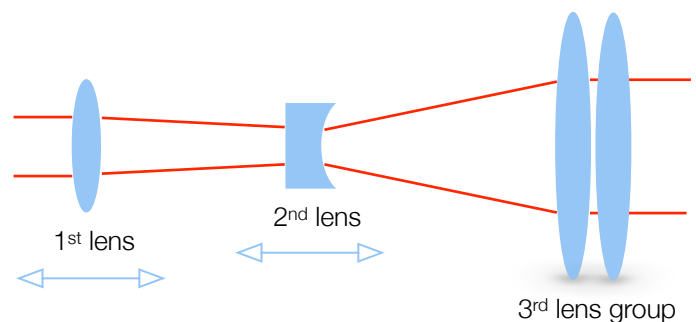

Fig 2. Schematic explanation of optical design for MEX18-ACH series motorised beam expander.

5. Product description

MEX series motorised laser beam expanders are used to increase or decrease laser beam diameter and adjust its divergence.

Standard or custom made beam expanders and reducers have a unique closed loop sliding-lens design, ensuring highest pointing stability and minimal dimensions.

5.1. Optical specifications

Magnification ranges	MEX13 - 1.0x - 3.0x MEX18 - 1.0x - 8.0x		
Clear input aperture	11 mm		
Clear output aperture	MEX13 - 23 mm MEX18 - 38 mm MEX18-ACH - 23 mm		
Optical elements	3 4 (MEX18-ACH)		
LIDT coating	10 [J/cm ²] (10 ns @ 1064 nm)		
Pointing stability during lens movement	<0.5 mrad (<0.2 mrad for PS version)		
Adjustment time	MIN to MAX - in 1 sec		
Available coatings			
A. Standard wavelenghts, nm			
	1 st harm	2 nd harm	3 rd harm
	1064	532	355
	1020 - 1040	510 - 520	343
	760-840	390 - 410	-
B. Dual wavelenghts, nm			
	1064 + 532	1030 + 515	800 + 400
C. Custom wavelenghts			
Custom coating available			

5.2. Mechanical specifications

	MEX13	MEX18	MEX18-ACH
Lenght	140 mm	237 mm	226 mm
Width	45 mm	45 mm	45 mm
Height	45 mm	45 mm	45 mm

5.3. Electronic specifications

Interface options:	
Terminal	Using commands described in p. 8 "Commands"
Software	Using BDS software
Input voltage	12 V
Transmission speed	up to 115,200 bits/s (RS-232) full speed USB 2.0

5.4. Conditions

Operating temperature	10 °C to 40 °C
Storage temperature	-15 °C to 50 °C

5.5. Interfaces

There are two type of connections available:

1. USB 2.0 and power plug for 12 V.
2. RS-232 and power plug for 12 V.

5.6. Wiring, Pinouts

Connectors and plugs (contacts):

Type	Contact	Connector
Communication (same for USB and RS-232)	Binder	Binder (modified)
	09-9767-00-04	09-9764-71-04
Power supply	Binder	Binder (modified)
	09-9747-00-03	09-9748-71-03

Pinouts:

Power supply	Communication	
	RS232	USB
DC 12 V		
1. GND	1. RS232 TX	1. USB D+
2. GND	2. RS232 RX	2. USB D-
3. +12 V DC	3. -	3. VUSB
	4. GND	4. GND

NOTE: RS-232 cable has standard DB9 female connector at one end:

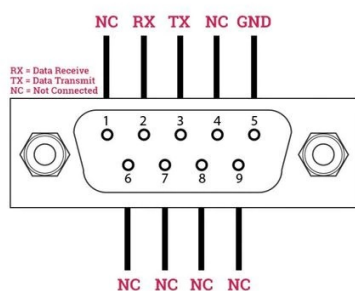

Fig 4. DB9 female connector pinout

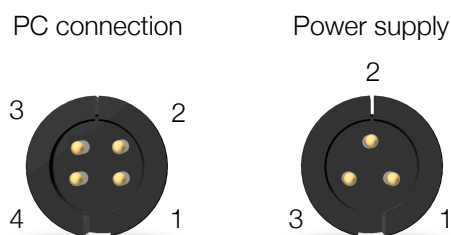

Fig 5. MEX connectors

5.7. Identification

Nameplate on beam expander:

Product, Expansion	MEX 1X-3X
Wavelength	515+1030 nm
Serial number	SN: 1B20050139

5.8. Voltage levels (RS-232)

The RS-232 standard defines the voltage levels that correspond to logical one and logical zero levels for the data transmission and the control signal lines. Valid signals are either in the range of +3 to +15 volts or the range -3 to -15 volts with respect to the "Common Ground" (GND) pin; consequently, the range between -3 to +3 volts is not a valid RS-232 level. For data transmission lines (TxD, RxD), logic one is defined as a negative voltage, the signal condition is called "mark". Logic zero is positive and the signal condition is termed "space".

MEX operates on signal levels of ± 5 V and can accept signal levels of up to ± 15 V. Because the voltage levels are higher than logic levels typically used by integrated circuits, special intervening driver circuits are required to translate logic levels. These also protect the device's internal circuitry from short circuits or transients that may appear on the RS-232 interface, and provide sufficient current to comply with the slew rate requirements for data transmission.

5.9. What's in the box?

Standard version includes:

1. Motorised beam expander
2. Software
3. Power supply DC 12V (GST60A12-P1J with modified snap in 09-9748-71-03 connector)
4. USB-A or RS-232 (D-Sub 9) cable with modified snap in 09-9764-71-04 connector

NOTE: Other accessories must be purchased separately

6. Software

6.1. Hardware requirements (recommended)

Processor	1 Ghz
RAM	512 Mb
Disk space	
32-bit	4,5 Gb
64-bit	4,5 Gb

6.2. System requirements

To install application you must have administrator rights on your computer.

To run BDS application Microsoft .NET 4.5.2 Framework or later must be installed. Installer detects Microsoft .NET Framework and installs it. Administrator privileges are required for installation. Contact your network administrator if you do not have administrator rights on the computer.

6.3. Supported client operating systems

- Windows Vista SP2
- Windows 7 SP1
- Windows 8
- Windows 8.1 (.NET included with OS)
- Windows 10 (.NET 4.6 included with OS)
- Windows Server 2008 SP2/R2
- Windows Server 2012 (.NET included with OS)

6.4. Installing the software

1. Check and download the latest BDS software from our website (www.optogama.com) or contact us directly at sales@optogama.com.
2. Run the downloaded software installation file. Installation window will appear, click “Next” to continue:

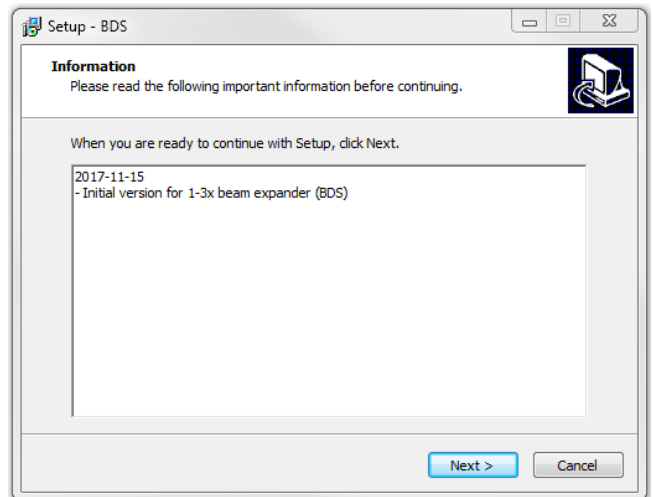

3. Select “Create a desktop shortcut” if it is necessary and click “Next”:

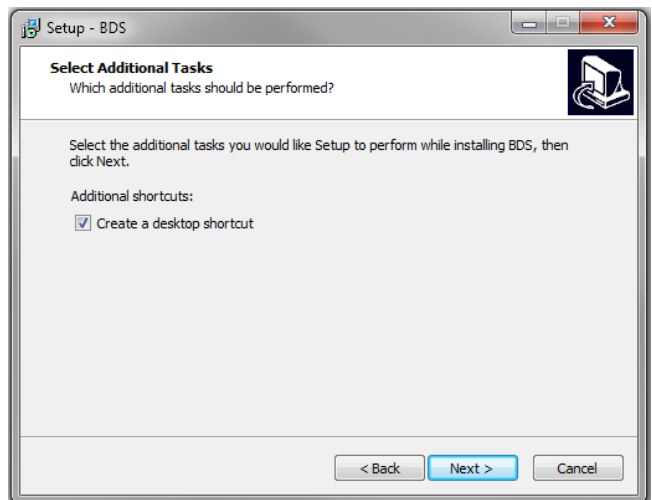

4. Review setup information and proceed the installation. To continue click “Install”:

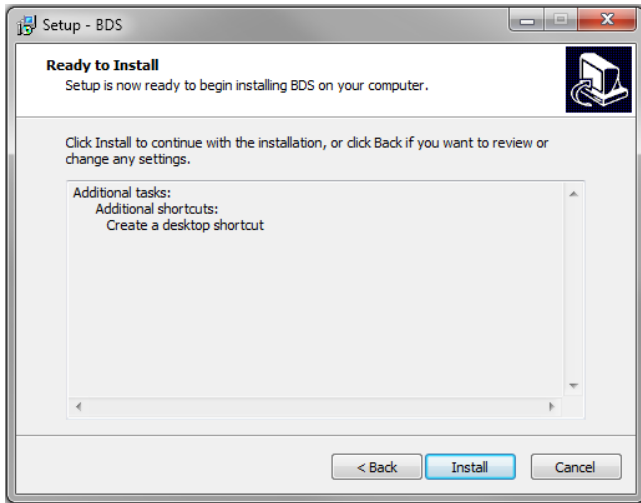

5. Setup will finish the installation:

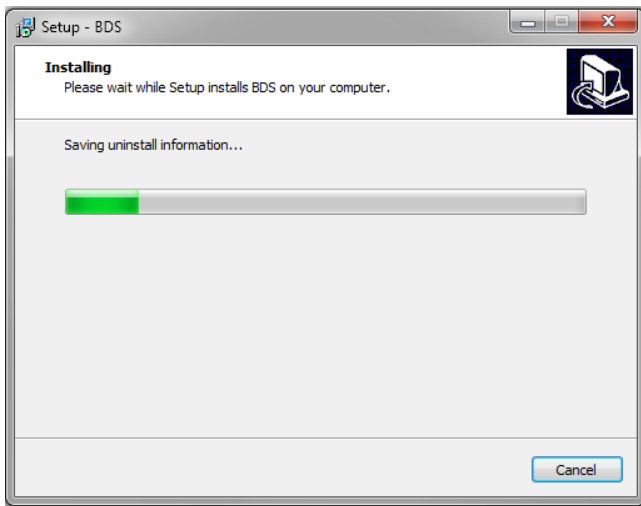

6. Press “Finish” to end the installation:

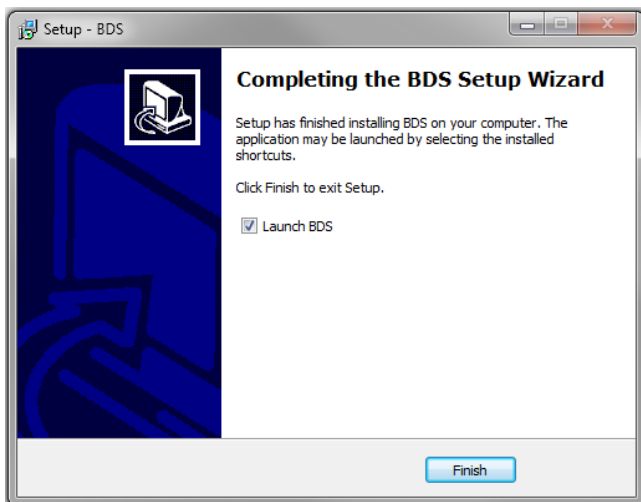

7. Connect the device and the PC via USB or RS232 cable.

NOTE: Lenses may move themselves when power is plugged in.

8. Plug in MEX power supply and AC adaptor to wall outlet.

9. The device will be detected and configured.

10. The device installation is complete.

6.5. Using the software

CAUTION! Do not switch the laser ON if the device is not adjusted properly, it may damage or destroy optical elements.

Launch BDS program using BDS icon on the desktop.



11. Device selector window will appear. Select COM port (to which the beam expander is connected) from the drop down menu. Press “Connect” to connect the device or “Rescan” if your device is not visible.

Select “Filter” when device is connected via USB cable. All other COM ports will be hidden except our device.

NOTE: When connecting via RS232 cable “Filter” must be deselected, otherwise device will not be visible.

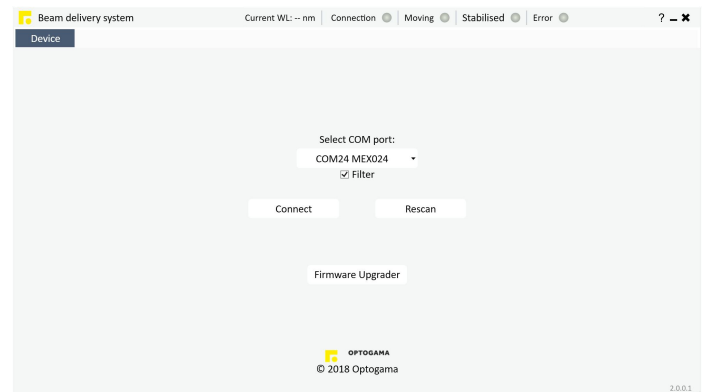

12. Once you are connected to your device you will be greeted by main program window for motorised beam expander. Window is the same for all devices but only specific options for control will be available. (Detailed explanation in p. 11 “Main window (expander mode) / (full beam control mode)”.

13. Select “Settings” in a sliding menu located on the left. Settings menu will appear. Select laser **wavelength** from drop down menu, then press “Set”.

14. Change Magnification offset to calibrate magnification values (*MOF*)

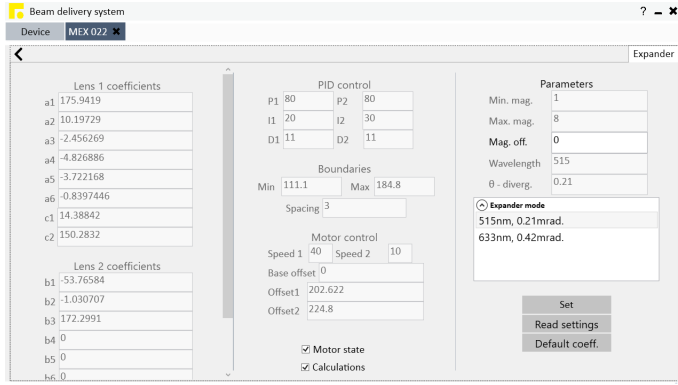

6.6. Main window

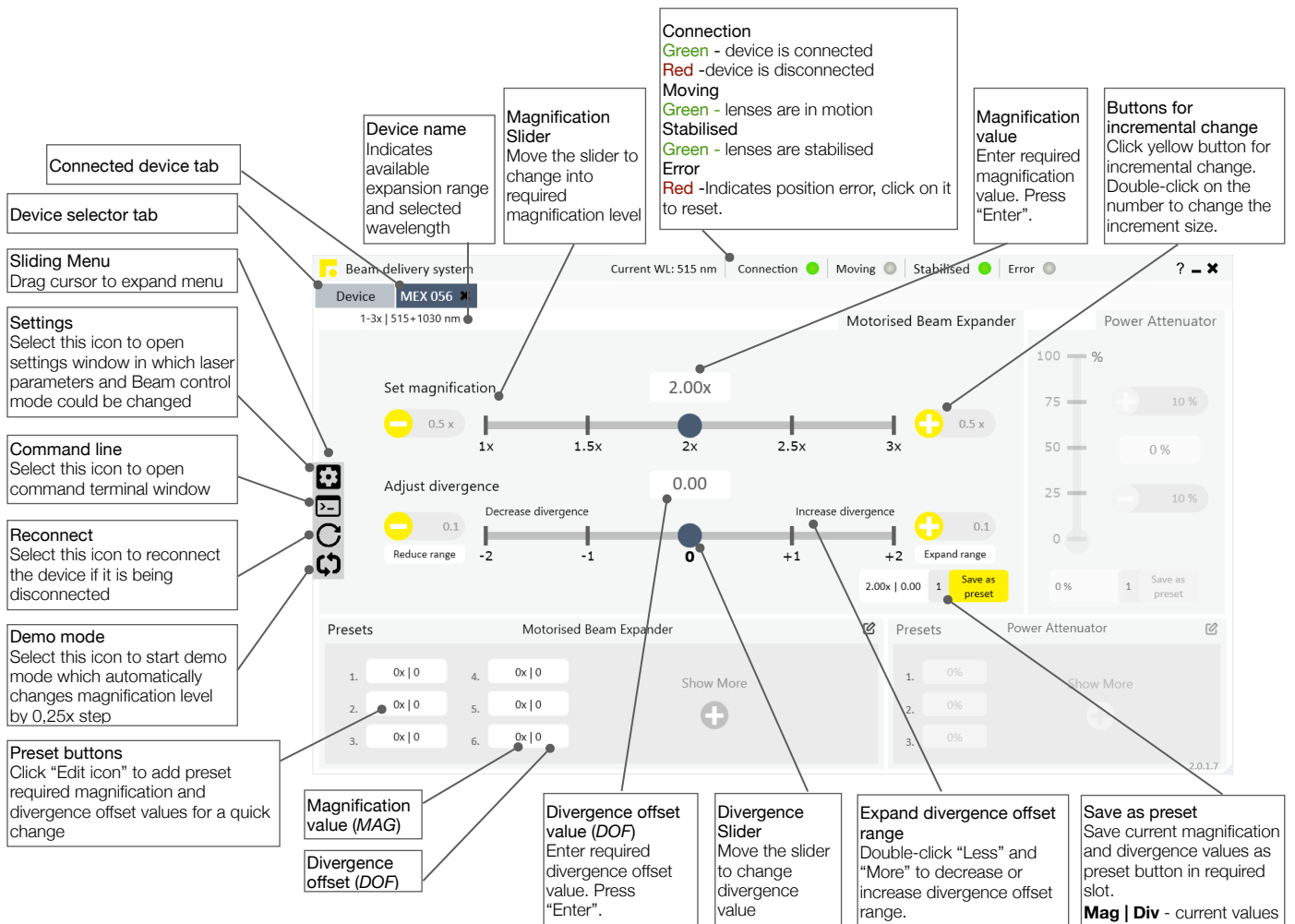

Connected device tab

Device selector tab

Sliding Menu
Drag cursor to expand menu

Settings
Select this icon to open settings window in which laser parameters and Beam control mode could be changed

Command line
Select this icon to open command terminal window

Reconnect
Select this icon to reconnect the device if it is being disconnected

Demo mode
Select this icon to start demo mode which automatically changes magnification level by 0,25x step

Preset buttons
Click “Edit icon” to add preset required magnification and divergence offset values for a quick change

Magnification value (MAG)

Divergence offset (DOF)

Device name
Indicates available expansion range and selected wavelength

Magnification Slider
Move the slider to change into required magnification level

Connection
Green - device is connected
Red - device is disconnected

Moving
Green - lenses are in motion
Stabilised
Green - lenses are stabilised
Error
Red - indicates position error, click on it to reset.

Magnification value
Enter required magnification value. Press “Enter”.

Buttons for incremental change
Click yellow button for incremental change. Double-click on the number to change the increment size.

Current WL: 515 nm | Connection ● | Moving ● | Stabilised ● | Error ●

Motorised Beam Expander

Set magnification: 2.00x

Adjust divergence: 0.00

Presets: 1. 0x | 0, 2. 0x | 0, 3. 0x | 0, 4. 0x | 0, 5. 0x | 0, 6. 0x | 0

Divergence offset value (DOF)
Enter required divergence offset value. Press “Enter”.

Divergence Slider
Move the slider to change divergence value

Expand divergence offset range
Double-click “Less” and “More” to decrease or increase divergence offset range.

Save as preset
Save current magnification and divergence values as preset button in required slot.
Mag | Div - current values

6.7. Magnification calibration. MOF coefficient

Command is used to adjust all magnification values:

- input **>0** (positive values) to increase Magnification offset
For. Ex. *MEX>MOF!_+0.7*
- input **<0** (negative values) to decrease Magnification offset
For. Ex. *MEX>MOF!_-0.6*
- to reset Magnification offset input 0.
For. Ex. *MEX>MOF!_0*

NOTE: MOF coefficient will be applied for all magnification values.

For. Ex. 1X magnification value (MAG_1) is chosen, but according to your laser beam parameters 1.09X actual magnification value is reached, so to calibrate magnification to required value *MEX>MOF_-0.4* or other negative value could be sent while observing the output.

6.8. Divergence adjustment. DOF coefficient

Once you have right magnification value you can adjust beam divergence. To do that, you have to change DOF coefficient (Divergence offset) with *MEX>DOF!_value* command:

- input **>0** to increase beam divergence (positive values)
For. Ex. *MEX>DOF!_+0.7*
- input **<0** to decrease beam divergence (negative values)
For. Ex. *MEX>DOF!_-0.6*
- to reset Divergence offset input 0.
For. Ex. *MEX>DOF!_0*

NOTE: DOF coefficient will be applied for all magnification values. If different Divergence offset must be set it has to be adjusted each time.

For. Ex. You can observe that laser beam beam is diverging too much and it must be collimated. To do that *MEX>DOF_-0.5* or other negative value must be sent while observing the output.

6.9.Updating the firmware

If your device firmware version doesn't match to software's firmware version while connecting to device via BDS software you'll be asked to update your device. If update request pops-up, but you want to keep current firmware and use BDS software, you must use software compatible with that firmware version. Compatible software had been delivered with device.

In order to update your device or rewrite device firmware - **USB cable** must be used (update through RS232 cable is not available).

1. Click button **"Firmware Upgrader"** in the main tab of BDS software:



2. In the opened window press **"Update"** button. You will be asked if you really want to update device:

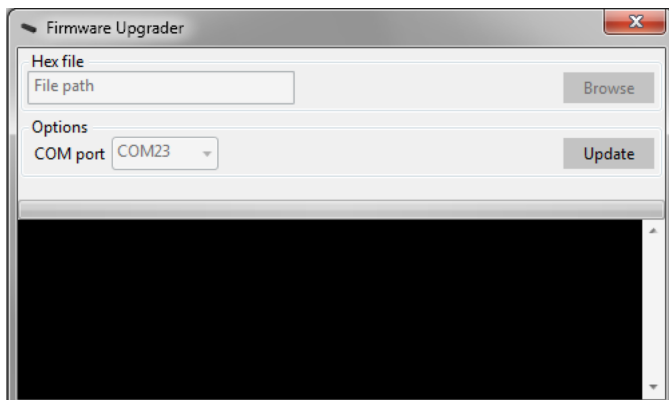

3. After a warning device **motors will be shut down** and update will start:



4. During update, if device is not corrupted, there'll be created a backup of settings stored in your device.

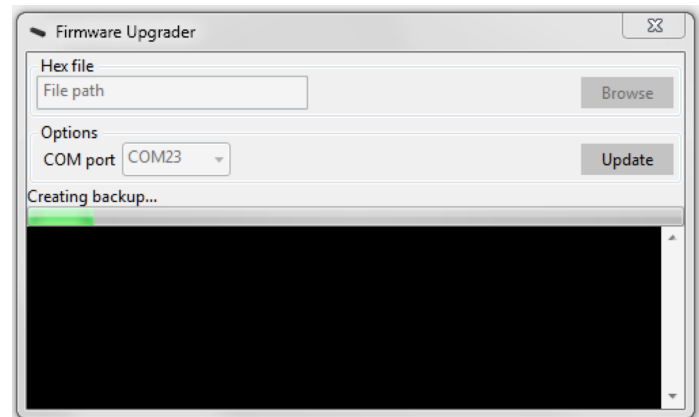

5. Update should be done in about a minute. If everything went successfully message box like this should pop-up:

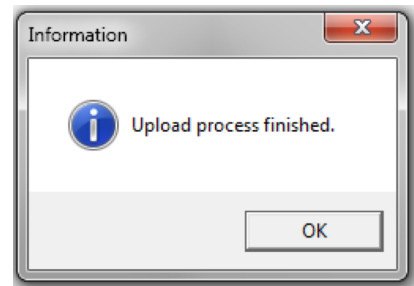

NOTE: After update turn off the "Firmware Upgrader", **reset device by removing USB and Power cables**. Reconnect the cables and connect to device using software.

6. You may get a warning sign saying that you must set default coefficients in case there are some error with device settings:

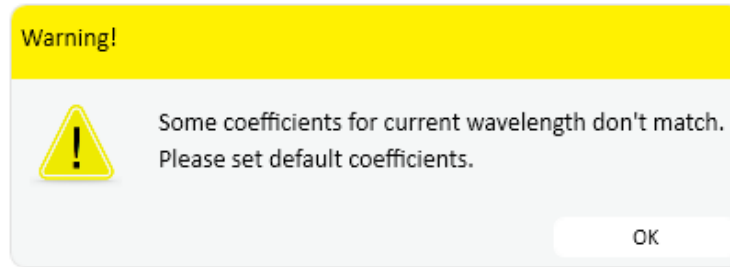

7. In order to rewrite default coefficients go to **Settings** -> **choose wavelength** -> Press **“Set”** -> Press **“Default coeff.”**

NOTE: In order to rewrite coefficients for all wavelengths you must repeat this action for all available wavelengths.

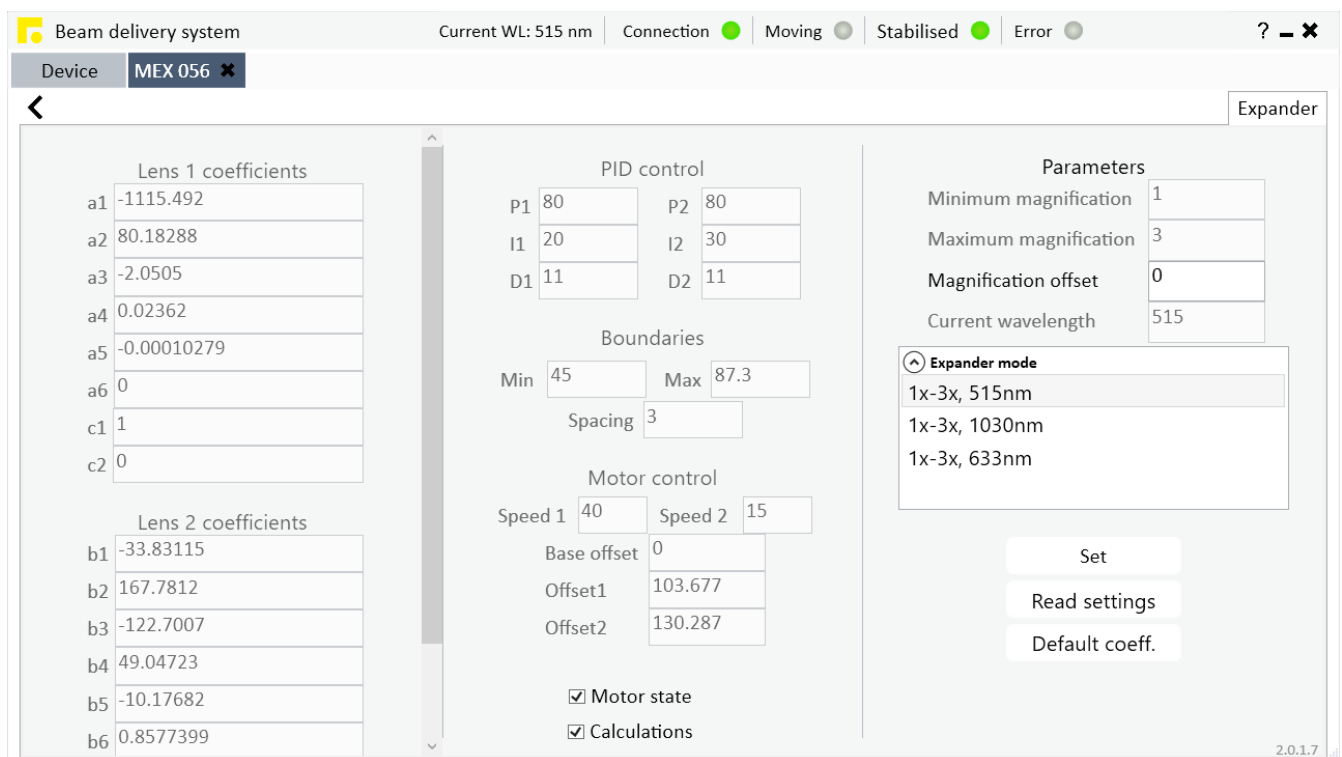

8. Finally, choose desired wavelength, check if **“Motor state”** and **“Calculations”** are marked then press **“Set”**. Coefficients for the wavelength will be automatically changed by device. Now you're ready to go.

9. Commands

9.1. Interface

The MEX can be controlled using either **USB 2.0** or **RS-232** interface. The device will switch to the required interface upon connection of the appropriate cable.

When using the RS-232 interface, MEX communicates on the **configured Baud rate (by default 57600)** (see Command descriptions), using **8 data bits, no parity and 1 stop bit**.

When the device is connected to the PC through the USB interface, it will appear as a **Virtual Serial COM port**, so

all PC side communications are interchangeable between the two interfaces.

All communications with MEX are conducted by sending **literal ASCII string commands terminated with the newline character \n**. For example, the beam expansion coefficient can be set to 2.5 by issuing a **“MEX>MAG!_2.5\n”** command to which the device will respond with **“MEX>MAG_2.5\n”**.

9.2. Description

Command	Response	Comments	Example usage	
			User command	Device response
Motion Magnification - MAG, Magnification offset - MOF, Divergence offset - DOF				
MEX>MAG?	MEX>MAG_X.XXX	Command used to get the current magnification value from the device.	MEX>MAG?	MEX>MAG_1.250
MEX>MAG!_X.XXX	MEX>MAG_X.XXX	Command used to set a new magnification values.	MEX>MAG!_2	MEX>MAG_2.000
			MEX>MAG!_2.5	MEX>MAG_2.500
			MEX>MAG!_2.547	MEX>MAG_2.547
MEX>MOF?	MEX>MOF_X.XXX	Command used to get current magnification adjustment coefficient (0 - means the lenses in the device is in their theoretical positions)	MEX>MOF?	MEX>MOF_0.3
MEX>MOF!_X.XXX	MEX>MOF_X.XXX	Command used to adjust magnification values: + to increase magnification - to decrease magnification (For. Ex. 1X magnification value (MAG_1) is chosen, but according to your laser beam parameters 1.09X actual magnification value is reached, so to calibrate magnification to required value MEX>MOF_-0.7 command must be sent)	MEX>MOF!_-0.7	MEX>MOF_-0.7
MEX>DOF?	MEX>DOF_X.XXX	Command used to get current divergence adjustment coefficient (0 - means the lenses in the device is in their theoretical positions)	MEX>DOF?	MEX>DOF_1.6

Command	Response	Comments	Example usage	
			User command	Device response
MEX>DOF!_X.XXX	MEX>DOF_X.XXX	Command used to collimate beam or get required divergence value: + to increase beam divergence - to decrease beam divergence (For. Ex. You can observe that laser beam beam is diverging too much and it must be collimated. To do that MEX>DOF_-0.5 or different values must be sent while observing the output)	MEX>DOF!_-0.5	MEX>DOF_-0.5
Settings Baud rate - BAUD, Wavelength - WL, Coefficients - CMAG,				
MEX>BAUD?	MEX>BAUD_baud rate	Command used to get baud rate. (57600 by default)	MEX>BAUD?	MEX>BAUD_115200
MEX>BAUD!_baud rate	MEX>BAUD_baud rate	Command used to set baud rate. Available speeds: 115200, 57600, 38400, 19200, 9600, 4800. Other values are ignored.	MEX>BAUD!_57600	MEX>BAUD_57600
MEX>CWL?	MEX>CWL_XXX.X	Command to get the current working wavelength in nanometers.	MEX>CWL?	MEX>CWL_532.0
MEX>CWL!_XXX.X	MEX>CWL_XXX.X	Command to set the current working wavelength in nanometers. The device will change its current working wavelength only if it matches one of the design wavelengths! Design wavelengths can be seen by issuing an MEX>INFO? Command.	MEX>CWL!_1064	MEX>CWL_1064.0
			MEX>CWL!_999	MEX>CWL_1064.0
			MEX>CWL!_532.1	MEX>CWL_532.0
MEX>CMAG?	MEX>CMAG_X.XXXXXX_Y.YYYYYY_Z.ZZZZZZ_U.UUUUUU_V.VVVVVV_W.WWWWWW_x.xxxxxx_y.yyyyyy_z.zzzzz_u.uuuuuu_v.vvvvv_w.wwwwww	Command used to get the current polynomial coefficients of curves A (uppercase) and B (lowercase). These coefficients are sent in scientific notation with 6 digits of precision starting with the 0th order and ending with the 5th order coefficient.	MEX>CMAG?	MEX>CMAG_-1.1154e3_8.0183e1_-2.0505e0_2.3620e-2_-1.0279e-4_0.0000_-1.1154e3_8.0183e1_-2.0505e0_2.3620e-2_-1.0279e-4_0.0000
MEX>CMAG!_X.XXXXXX_Y.YYYYYY_Z.ZZZZZZ_U.UUUUUU_V.VVVVVV_W.WWWWWW_x.xxxxxx_y.yyyyyy_z.zzzzz_u.uuuuuu_v.vvvvv_w.wwwwww	MEX>CMAG_X.XXXXXX_Y.YYYYYY_Z.ZZZZZZ_U.UUUUUU_V.VVVVVV_W.WWWWWW_x.xxxxxx_y.yyyyyy_z.zzzzz_u.uuuuuu_v.vvvvv_w.wwwwww	Command used to set the new polynomial coefficients of curve A (uppercase) and B (lowercase). These coefficients are sent in scientific notation with 6 digits of precision starting with the 0th order and ending with the 5th order coefficient.	MEX>CMAG!_-1.1154e3_8.0183e1_-2.0505e0_2.3620e-2_-1.0279e-4_0.0000_-1.1154e3_8.0183e1_-2.0505e0_2.3620e-2_-1.0279e-4_0.0000	MEX>CMAG_-1.1154e3_8.0183e1_-2.0505e0_2.3620e-2_-1.0279e-4_0.0000_-1.1154e3_8.0183e1_-2.0505e0_2.3620e-2_-1.0279e-4_0.0000
Information Device state - STATUS, information - INFO, Serial number - ID				
		Command used to get the current state of the device. First flag signifies if element actuation is enables or disabled. Second flag signifies if automatic target coordinate calculation is active. Third flag signifies if calculation mode is inverted or direct. The error byte shows if	MEX>STATUS?	ENA_CON_DIRECT_ERR_0
			MEX>STATUS?	DIS_CON_INVERT_ERR_32

Command	Response	Comments	Example usage	
			User command	Device response
MEX>STATUS?	ENA_CON_DIRECT_ERR_XXX	any error state is active. Bit number meaning if value "high" 7 - Max position boundary exceeded. 6 - Min position boundary exceeded. 5 - Spacing violation between optical elements. 4 - Calculation error. 3 - Internal device failure. 2 - Reserved. 1 - Stabilizing. 0 - Optical elements in motion.	MEX>STATUS?	DIS_COF_DIRECT_ERR_255
MEX>INFO?	MEX>MMG_X.XXX_Y.YY Y_MDV_J.JJJ_K.KKK_C WL_QQQ.Q_WL_ZZZ.Z_ UUU.U_VVV.V_WWW.W	Command used to get the current configuration of the device.	MEX>INFO?	MEX>MMG_8.000_1.000_ MDV_2.000_1.000_CWL_ 532.0_WL_1064.0_532.0_ 0_0
MEX>ID?	MEX>_1BXXXXXXXX	Command used to get serial number.	MEX>ID?	MEX>_1B19040075
MEX>MMG?	MEX>MMG_X.XXX_Y.YY Y	Command used to get the boundaries of available expansion coefficients. The upper boundary is sent first, followed by the lower boundary. These boundaries are specific to the optical assembly and are set at the factory.	MEX>MMG?	MEX>MMG_8.000_1.000
Other Echo, Reset, Motor ON/OFF				
MEX>ECHO!	MEX>ECHO	Command used for troubleshooting. The device echoes the command sent to it before sending the response.	MEX>ECHO! MEX>MAG?	MEX>ECHO MEX>MAG? MEX>MAG_2
MEX>NOECHO!	MEX>NOECHO	Command used to disable ECHO command.		
MEX>RESET!		Command used to reset the device		
MEX>ON!	MEX>ON	Command used to enable optical element actuation.	MEX>ON!	MEX>ON
MEX>OFF!	MEX>OFF	Command used to disable optical element actuation	MEX>OFF!	MEX>OFF
BOOTMODE	BOOTMODE	Command used to switch the device into firmware update mode.	BOOTMODE	BOOTMODE

9.3. Serial communication example in Python

```

1  import serial
2  import glob
3  import sys
4  import time
5
6  def serial_ports():
7      """ Lists serial port names
8
9          :raises EnvironmentError:
10             On unsupported or unknown platforms
11          :returns:
12             A list of the serial ports available on the system
13      """
14      if sys.platform.startswith('win'):
15          ports = ['COM%s' % (i + 1) for i in range(256)]
16      elif sys.platform.startswith('linux') or sys.platform.startswith('cygwin'):
17          # this excludes your current terminal "/dev/tty"
18          ports = glob.glob('/dev/tty[A-Za-z]*')
19      elif sys.platform.startswith('darwin'):
20          ports = glob.glob('/dev/tty.*')
21      else:
22          raise EnvironmentError('Unsupported platform')
23
24      result = []
25      for port in ports:
26          try:
27              s = serial.Serial(port)
28              s.close()
29              result.append(port)
30          except (OSError, serial.SerialException):
31              pass
32      return result
33
34  if __name__ == "__main__":
35      ports = serial_ports()
36      print("Select port number ( starting from 0, 1, 2 etc.):")
37      print(ports)
38      port = ports[int(input())]
39      print(port)
40
41      # configure the serial connections (the parameters differs on the device you are connecting to)
42      ser = serial.Serial(
43          port=port,
44          baudrate=57600,
45          parity=serial.PARITY_ODD,
46          stopbits=serial.STOPBITS_TWO,
47          bytesize=serial.EIGHTBITS,
48          timeout=1 #second
49      )
50      ser.isOpen()
51
52      print('Enter your commands below.\r\nInsert "exit" to leave the application.')
53      cmd=1
54      while 1 :
55          # get keyboard input
56          cmd = input(">>> ")
57          # Python 2 users
58          # input = raw_input(">>> ")
59          if cmd == 'exit':
60              ser.close()
61              break
62          else:
63              # send the string to the device
64              # (note that I happend a \n line feed to the characters - this is requested by device)
65              cmdBytes = (cmd + '\n').encode()
66              ser.write(cmdBytes)
67              out = ''
68              out = str(ser.readline())
69              if out != '':
70                  print(">>>" + out)

```

10. Technical drawings

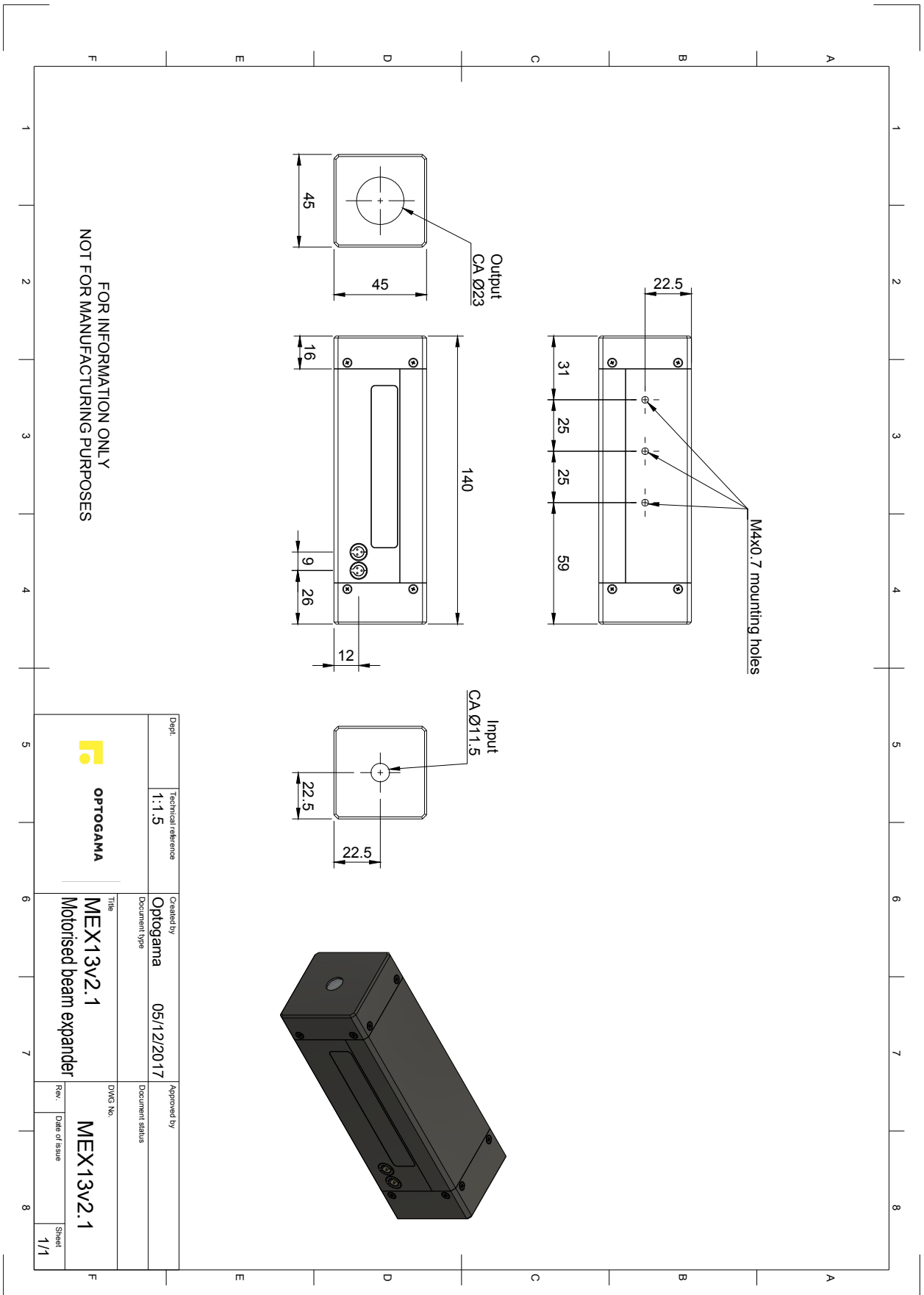

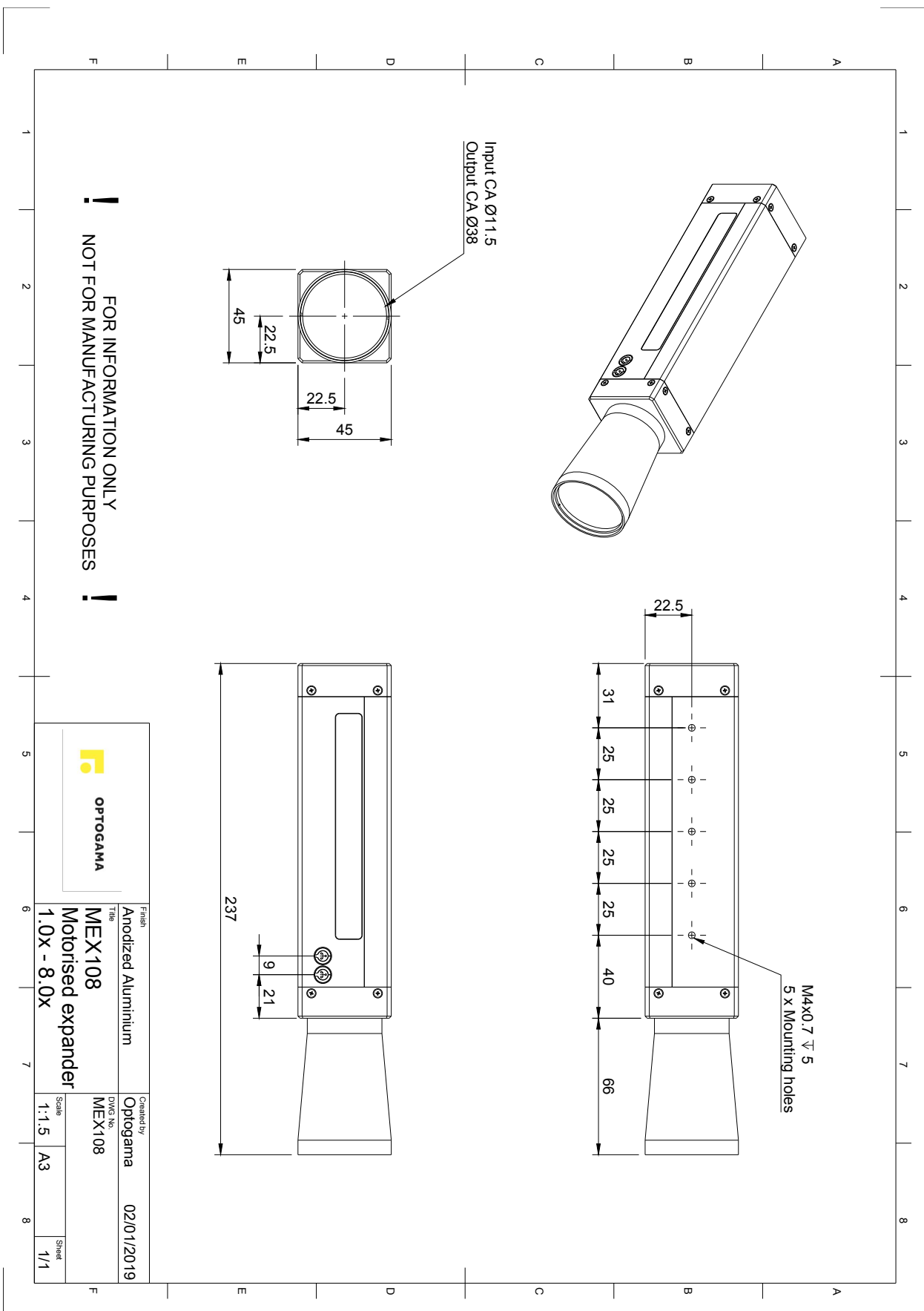

Input CA Ø11.5
Output CA Ø38

M4x0.7 5
5 X Mounting holes

FOR INFORMATION ONLY
NOT FOR MANUFACTURING PURPOSES

		Title MEX108 Motorised expander 1.0X - 8.0X	Created by Optogama 02/01/2019
Finish Anodized Aluminium	Scale 1:1.5	DWG No. MEX108	Sheet 1/1

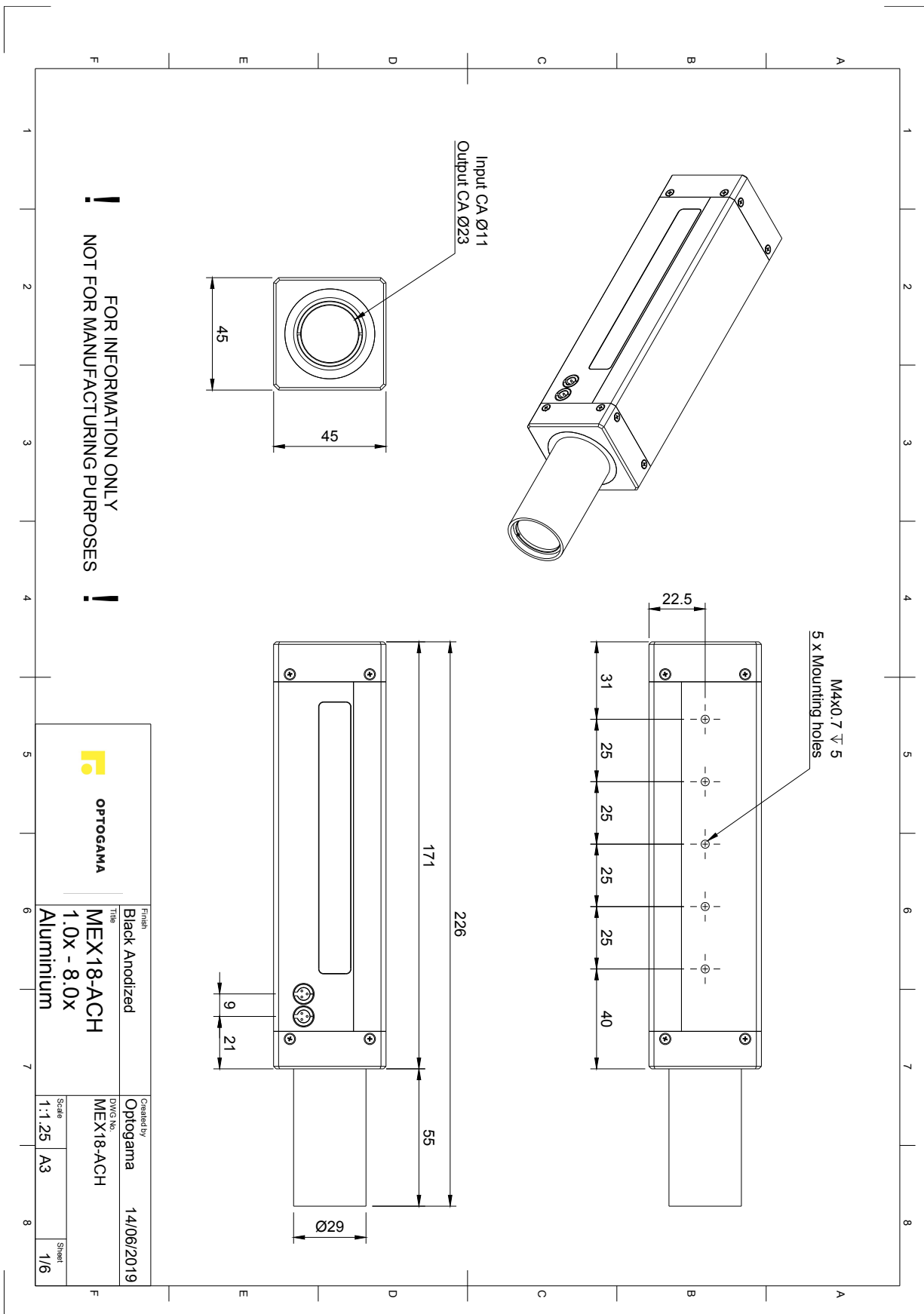

		Created by Optogama 14/06/2019	
Finish Black Anodized		DWG No. MEX18-ACH	
Title MEX18-ACH 1.0x - 8.0x		Scale 1:1.25 A3	
Material Aluminium		Sheet 1/6	

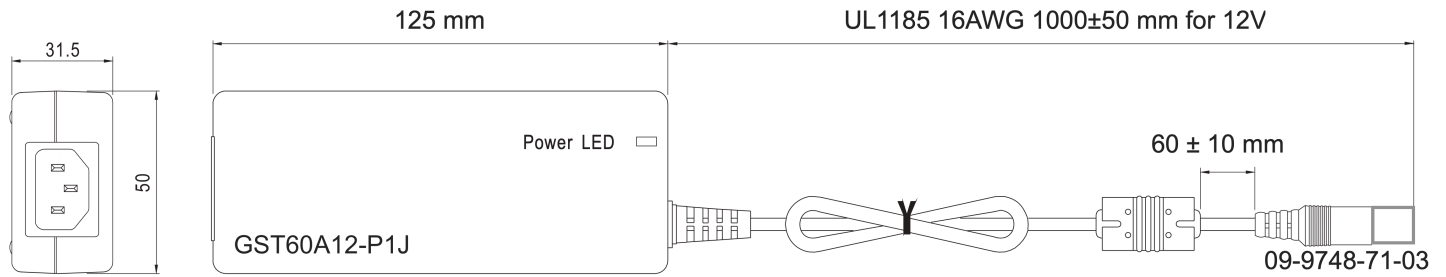

AC Inlet
IEC320-C14

Technical data

Brand	Mean Well
Item number	GST60A12-P1J
Series	GST60A
Description	AC-DC Industrial desktop adaptor; Output 12Vdc at 5A; 3 pole AC inlet IEC320-C14
Application	ITE EN/UL/IEC 60950
Technology	AC/DC
Power Format	Desktop
Output Power (W)	60
Output Voltage (V)	12
Output Current (A)	5
Input Voltage (V)	90 - 264 Universal Input 110/230V
IP Rating	No IP assigned
Width (mm)	50
Height (mm)	31.5
Depth (mm)	125

OPTOGAMA, UAB
Mokslininku str. 2A,
LT-08412, Vilnius, Lithuania
+37052194884
sales@optogama.com
www.optogama.com



OPTOGAMA